



Airotic

Importer, Marketed & Exporter

Products

Catalogue 2022

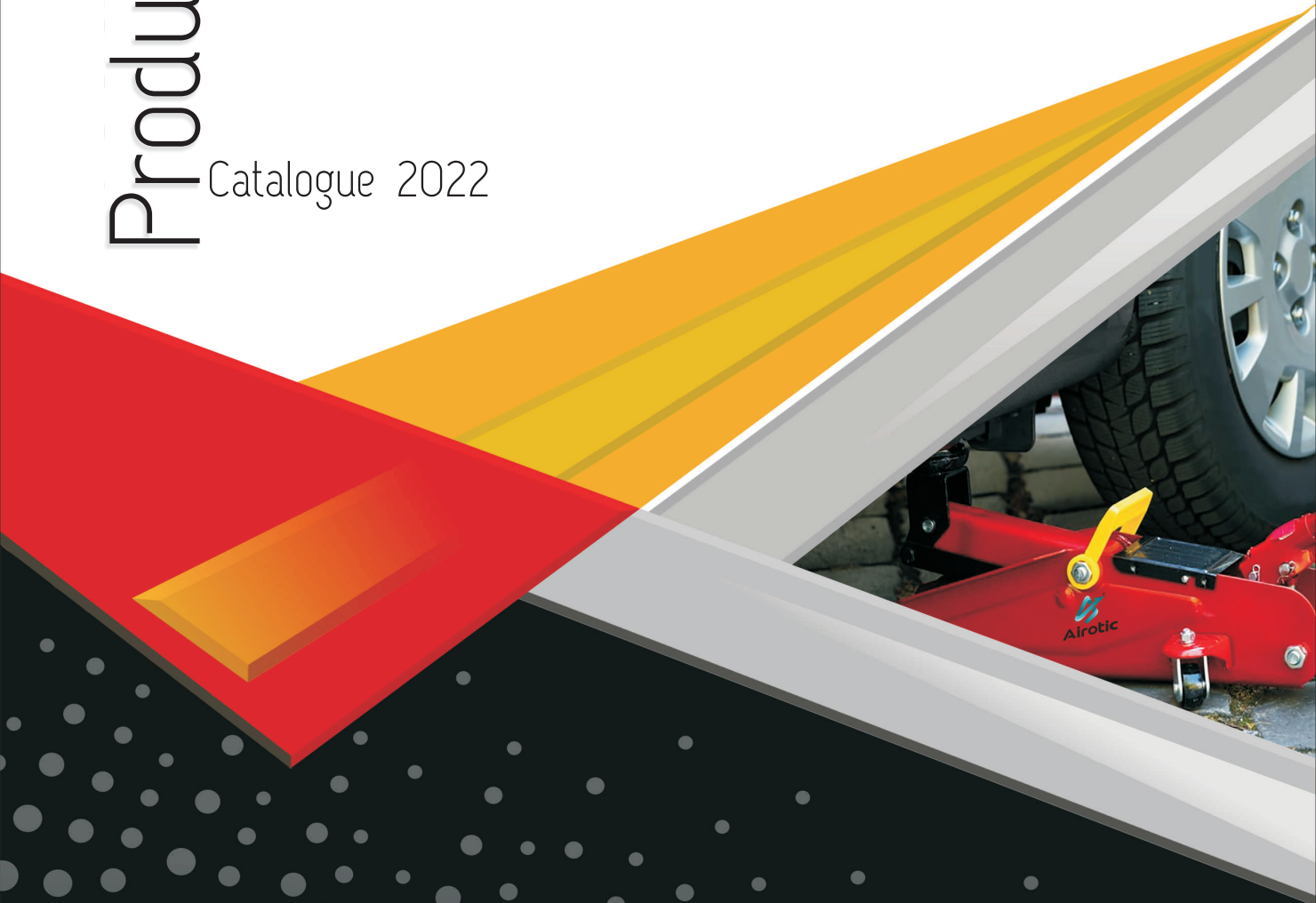

Garage



Service Station



Vaccum Cleaning



1.2" IMPACT WRENCH

AR-210

HSN Code (GST-%)	: 84678990 (18%)
Square Drive	: 1/2"
Free Speed	: 7000 rpm
Max. Torque	: 340 N.m.
Air Inlet	: 1/4"
Air Hose (I.D.)	: 3/8"
Air Consumption	: 7.5 cfm.
Working Pressure	: 90 psi (6.3 Bar)
Length x Height	: 8.7" x 7.87" (Inch)
Net. Weight	: 2.18 kgs
Standard Packing	: 5 pc.

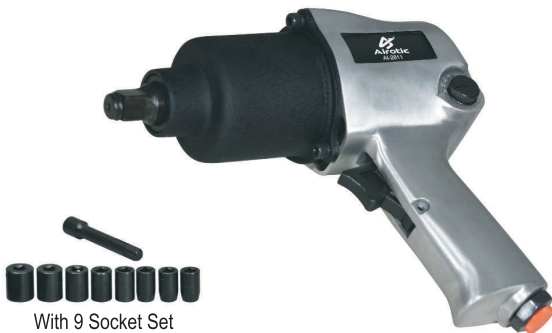

1.2" IMPACT WRENCH

AR-2811

HSN Code (GST-%)	: 84678990 (18%)
Free Speed	: 8000 rpm
Bolt Capacity	: 16 mm
Max. Torque	: 580 N.m.
Air Inlet	: 1/4"
Air Pressure	: 6-8 kg
Anvil Length	: 1"
Moment Bound	: 200-800 N.m.
Net. Weight	: 2.8 kgs
Carton Measurement	: 420x220x260 mm
Standard Packing	: 5 pc.



1.2" IMPACT WRENCH

AR-3600

HSN Code (GST-%)	: 84678990 (18%)
Free Speed	: 7500 rpm
Bolt Capacity	: 18 mm
Max. Torque	: 850 N.m.
Air Inlet	: 1/4"
Air Pressure	: 6-8 kg
Anvil Length	: 1"
Moment Bound	: 200-800 N.m.
Net. Weight	: 3 kg
Carton Measurement	: 28.7x9.6x7.6 mm
Standard Packing	: 5 pc.



1.2" IMPACT WRENCH

AR-2805

HSN Code (GST-%)	: 84678990 (18%)
Free Speed	: 11000 rpm
Bolt Capacity	: 13 mm
Max. Torque	: 550 N.m.
Air Inlet	: 1/4"
Air Pressure	: 6-3 / 8 kg
Anvil Length	: 1"
Moment Bound	: 200-400 N.m.
Net Weight	: 1.4 kg
Carton Measurement	: 320x375x210 mm
Standard Packing	: 10 pcs

PNEUMATIC TOOL



With 2 Socket Set

3/4" IMPACT WRENCH

AR-760

HSN Code (GST-%)	: 84678990 (18%)
Free Speed	: 4600 rpm
Bolt Capacity	: 33 mm
Max. Torque	: 1600 N.m.
Air Inlet	: 3/8"
Air Pressure	: 6-10 kg
Anvil Length	: 1.5"
Moment Bound	: 500-1400 N.m.
Net. Weight	: 7.3 kg
Size of Socket	: 32, 33 mm
Carton Measurement	: 330x300x455 mm
Standard Packing	: 4 pc.



With 2 Socket Set

1" IMPACT WRENCH

AR-751B

HSN Code (GST-%)	: 84678990 (18%)
Free Speed	: 5300 rpm
Bolt Capacity	: 32 mm
Max. Torque	: 1450 N.m.
Air Inlet	: 3/8"
Air Pressure	: 6-10 kg
Anvil Length	: 1.5"
Moment Bound	: 600-1300 N.m.
Net. Weight	: 5.8 kg
Size of Socket	: 32, 33 mm
Carton Measurement	: 330x300x455 mm
Standard Packing	: 2 pc.



With 2 Socket Set

1" IMPACT WRENCH

AR-860

HSN Code (GST-%)	: 84678990 (18%)
Free Speed	: 4500 rpm
Bolt Capacity	: 41 mm
Max. Torque	: 2180 N.m.
Air Inlet	: 1/2"
Air Pressure	: 8-12 kg
Anvil Length	: 1.5"
Moment Bound	: 500-1800 N.m.
Net. Weight	: 12.5 kgs
Size of Socket	: 32, 33 mm
Carton Measurement	: 375x295x308 mm
Standard Packing	: 2 pc.

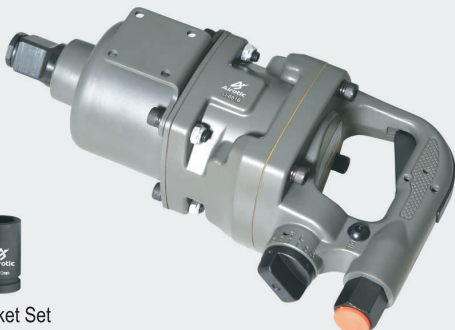

With 2 Socket Set

3/4" 1" IMPACT WRENCH

AR-681B

HSN Code (GST-%)	: 84678990 (18%)
Free Speed	: 4800 rpm
Bolt Capacity	: 41 mm
Max. Torque	: 1800 N.m.
Air Inlet	: 1/2"
Air Pressure	: 8-10 kg
Anvil Length	: 1.5"
Moment Bound	: 600-1600 N.m.
Net. Weight	: 7.6 kgs
Size of Socket	: 32, 33 mm
Carton Measurement	: 438x240x460 mm
Standard Packing	: 1 pc.

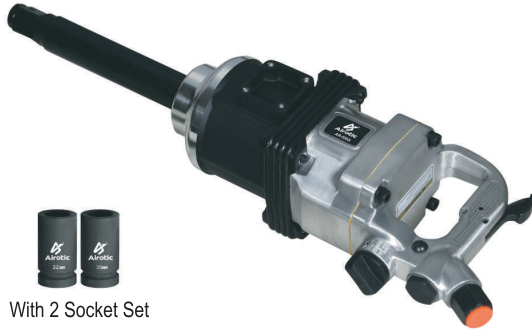

With 2 Socket Set

1" IMPACT WRENCH

AR-550A

HSN Code (GST-%)	: 84678990 (18%)
Free Speed	: 4200 rpm
Bolt Capacity	: 41 mm
Max. Torque	: 2980 N.m.
Air Inlet	: 1/2"
Air Pressure	: 8-12 kg
Anvil Length	: 8"
Moment Bound	: 900-1850 N.m.
Net. Weight / Gross Weight	: 14.0 kgs / 18 kgs
Size of Socket	: 32, 33 mm
Carton Measurement	: 730x253x88 mm
Standard Packing	: 1 pc.



With 2 Socket Set

1" IMPACT WRENCH

AR-A12

HSN Code (GST-%)	: 84678990 (18%)
Free Speed	: 3800 rpm
Bolt Capacity	: 48 mm
Max. Torque	: 3880 N.m.
Air Inlet	: 1/2"
Air Pressure	: 8-12 kg
Anvil Length	: 8"
Moment Bound	: 1300-2600 N.m.
Net. Weight / Gross Weight	: 17.5 kgs / 21 kgs
Size of Socket	: 32, 33 mm
Carton Measurement	: 730x245x195 mm
Standard Packing	: 1 pc.



With 2 Socket Set

HAND OPERATED WRENCH

AR-02

HSN Code (GST-%)	: 84678990 (18%)
Max. Torque	: 4000 N/M
Length	: 360 mm
Size of Sockets	: 32 mm & 33 mm
Weight	: 9.200 kg
Standard Packing	: 2 Pcs.



AIR HOSE PIPE 3/5 Leyar

AR-8.5

HSN Code (GST-%)	: 39172390 (18%)		
ID	8.5mm	10.5mm	13.5mm
OD	14.5mm	17mm	19mm
Length	100 (m)	100 (m)	100 (m)
Bar	60 kg	40 kg	40 kg
B.P. Bar	160 to 220 psi	120 psi	120 psi

AIR COMPRESSOR



10 Liter Air Compressor

AR-10

HSN Code (GST-%)	: 84144090 (18%)
Power	: 2 HP
Cylinder	: 42 mm
Speed RPM	: 2850
Tank Size	: 10 Ltr.
Max. Pressure	: 8 kg 115 psi
Capacity L/Min	: 116
Weight	: 17 kg
Capacity CFM	: 4.1
Carton Size	: 410x210x500 mm



25 Liter Air Compressor

AR-25

HSN Code (GST-%)	: 84144090 (18%)
Power	: 2.5 HP
Cylinder	: 42 mm
Speed RPM	: 2850
Tank Size	: 25 Ltr.
Max. Pressure	: 8 kg 115 psi
Capacity L/Min	: 158
Weight	: 23 kg
Capacity CFM	: 5.5
Carton Size	: 570x260x580 mm



30 Liter Air Compressor

AR-30

HSN Code (GST-%)	: 84144090 (18%)
Power	: 2.5 HP
Cylinder	: 42 mm
Speed RPM	: 2850
Tank Size	: 30 Ltr.
Max. Pressure	: 8 kg 115 psi
Capacity L/Min	: 192
Weight	: 27.5 kg
Capacity CFM	: 6.7
Carton Size	: 590x260x580 mm



60 Liter Air Compressor

AR-60

HSN Code (GST-%)	: 84144090 (18%)
Power	: 3 HP
Cylinder	: 47 mm
Speed RPM	: 2850
Tank Size	: 60 Ltr.
Max. Pressure	: 8 kg 115 psi
Capacity L/Min	: 210
Weight	: 42 kg
Capacity CFM	: 7.10
Carton Size	: 700x310x660 mm



10 Liter Air Compressor

AR-100F

HSN Code (GST-%)	: 84144090 (18%)
Voltage (V)	: 220/110 V
Frequency (Hz)	: 50/60Hz
Power (KW/HP)	: 550 W 1 HP
Speed (RPM)	: 1480
Capacity (L/min)	: 50 Ltr.
Nosie (dB)	: 48
Pressure (BAR)	: 0.8 kg / 115 psi
Tank (L)	: 10 L
LxWxH (mm)	: 460x200x530mm
Weight (kg)	: 16



25 Liter Air Compressor

AR-250F

HSN Code (GST-%)	: 84144090 (18%)
Voltage (V)	: 220/110 V
Frequency (Hz)	: 50/60Hz
Power (KW/HP)	: 550 W 1 HP
Speed (RPM)	: 1480
Capacity (L/min)	: 110
Nosie (dB)	: 50
Pressure (BAR)	: 8 kg / 115 psi
Tank (L)	: 25 L
LxWxH (mm)	: 500x300x510mm
Weight (kg)	: 22



30 Liter Air Compressor

AR-300F

HSN Code (GST-%)	: 84144090 (18%)
Voltage (V)	: 220/110 V
Frequency (Hz)	: 50/60Hz
Power (KW/HP)	: 550W / 1HP
Speed (RPM)	: 1480
Capacity (L/min)	: 120
Nosie (dB)	: 55
Pressure (BAR)	: 8 kg / 115 psi
Tank (L)	: 30 L
LxWxH (mm)	: 520x320x530mm
Weight (kg)	: 24



50 Liter Air Compressor

AR-500F

HSN Code (GST-%)	: 84144090 (18%)
Voltage (V)	: 220/110 V
Frequency (Hz)	: 50/60Hz
Power (KW/HP)	: 750W / 1.5HP
Speed (RPM)	: 1480
Capacity (L/min)	: 140 psi
Nosie (dB)	: 55
Pressure (BAR)	: 8 kg / 115 psi
Tank (L)	: 50 L
LxWxH (mm)	: 690x300x630mm
Weight (kg)	: 44

OIL FREE AIR COMPRESSOR



60 Liter Air Compressor

AR-60OF

HSN Code (GST-%)	: 84144090 (18%)
Voltage (V)	: 220/110 V
Frequency (Hz)	: 50/60Hz
Power (KW/HP)	: 1100W / 2HP
Speed (RPM)	: 1480
Capacity (L/min)	: 150 psi
Nosie (dB)	: 58
Pressure (BAR)	: 10 kg / 150 psi
Tank (L)	: 60 L
LxWxH (mm)	: 690x320x660mm
Weight (kg)	: 55



50 Liter Air Compressor

AR-50OFD

HSN Code (GST-%)	: 84144090 (18%)
Voltage (V)	: 220/110 V
Frequency (Hz)	: 50/60Hz
Power (KW/HP)	: 750W / 1.5 kw 2 HP
Speed (RPM)	: 1480
Capacity (L/min)	: 150 psi
Nosie (dB)	: 58
Pressure (BAR)	: 10 kg / 150 psi
Tank (L)	: 50 L
LxWxH (mm)	: 690x320x660mm
Weight (kg)	: 55



Air Compressor Head

AR-550/750

HSN Code (GST-%)	: 84144090 (18%)
Voltage (V)	: 220/110 V
Frequency (Hz)	: 50/60Hz
Power (KW/HP)	: 550W / 1HP
Speed (RPM)	: 1480
Capacity (L/min)	: 120
Nosie (dB)	: 50
Pressure (BAR)	: 8kg / 115psi
Standard Packing	: 1 pc.



Air Compressor Mini

AR-16

HSN Code (GST-%)	: 84144090 (18%)
Speed	: 1450-1700 rpm
Suitable for Airbrush (Nozzle)	: 0.2-1.0 mm
Piston	: Oil Free
Power	: 1/6 HP
Air Flow	: 20-23 ltr/min
Electric Cable	: 1.9 mtr.
Weight	: 3.9 kg
Product Size (lxbxh)	: 255x135x205 mm
Standard Packing	: 5 pcs.

TROLLEY JACK



HYDRAULIC GARAGE JACK

AR-2

HSN Code (GST-%)	: 84254200 (18%)
Capacity	: 2 Ton
Min./Max. Height (mm)	: 135/300
Nw/Gw (kg)	: 5.6 / 7
Cylinder	: 1
Packing Size (cm)	: 43x21x16
Standard Packing	: 4 pcs.



HYDRAULIC GARAGE JACK

AR-2H

HSN Code (GST-%)	: 84254200 (18%)
Capacity	: 2 Ton
Min./Max. Height (mm)	: 130/330
Nw/Gw (kg)	: 8.5 / 9.5
Cylinder	: 1
Packing Size (cm)	: 48x24x16
Standard Packing	: 4 pcs.



HYDRAULIC GARAGE JACK

AR-3

HSN Code (GST-%)	: 84254200 (18%)
Capacity	: 3 Ton
Min./Max. Height (mm)	: 140/500
Nw/Gw (kg)	: 28/29
Cylinder	: 1
Packing Size (cm)	: 68x36x21.5
Standard Packing	: 1 pc.



HYDRAULIC GARAGE JACK

AR-3H

HSN Code (GST-%)	: 84254200 (18%)
Capacity	: 3 Ton
Min./Max. Height (mm)	: 125/460
Nw/Gw (kg)	: 33/31
Cylinder	: 2
Packing Size (mm)	: 801x415x200
Standard Packing	: 1 pc.

TROLLEY JACK

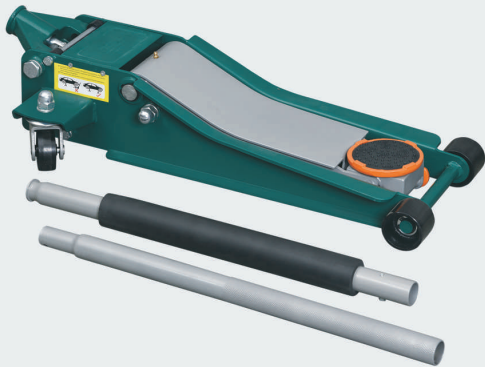

HYDRAULIC GARAGE JACK

AR-4

HSN Code (GST-%)	: 84254200 (18%)
Capacity	: 4 Ton
Min./Max. Height (mm)	: 76/505
Nw/Gw (kg)	: 34/36
Cylinder	: 2
Packing Size (mm)	: 801x415x200
Standard Packing	: 1 pc.



GARAGE JACK 5 IN 1

AR-5

HSN Code (GST-%)	: 84254200 (18%)
Capacity	: 5 Ton
Min./Max. Height (mm)	: 155/450
Nw/Gw (kg)	: 8.8-10kg
Cylinder	: 1
Packing Size (cm)	: 49.5x36.5x34.5
Standard Packing	: 3 pc.



RIMLOCK RING REMOVER

AR-1000/20

HSN Code (GST-%)	: 84254200 (18%)
------------------	------------------

TYRE MOUNTING & D MOUNTING TOOLS

AR-1000/22

HSN Code (GST-%)	: 84254200 (18%)
------------------	------------------



FRL WITH GAUGE L/H

AR-1/2

HSN Code (GST-%)	: 84213990 (18%)
Size	: 1/4 3/8 1/2
Moq	: 10
Standard Packing	: 9 pcs.



Vacuum Cleaner

AR-30

HSN Code (GST-%)	: 85081900 (18%)
Power	: 1500 W
Vacuum Suction	: 200 m Bar
Capacity	: 30 Ltr
Height	: 57 cm
Diameter	: 32 cm
Airflow	: 53 L/S
Function	: Wet/Dry
Voltage	: 220V-240V
Gross Weight	: 10.3 kg
Standard Packing	: 1 pc.



Vacuum Cleaner

AR-35

HSN Code (GST-%)	: 85081900 (18%)
Power	: 1500 W
Vacuum Suction	: 200 m Bar
Capacity	: 35 Ltr
Height	: 76 cm
Diameter	: 32 cm
Airflow	: 53 L/S
Function	: Wet/Dry
Voltage	: 220V-240V
Gross Weight	: 11.8 kg
Standard Packing	: 1 pc.



Vacuum Cleaner

AR-60

HSN Code (GST-%)	: 85081900 (18%)
Power	: 1800 W
Vacuum Suction	: 250 m Bar
Capacity	: 60 Ltr
Height	: 88 cm
Diameter	: 38 cm
Airflow	: 53 L/S
Function	: Wet/Dry
Voltage	: 220V-240V
Gross Weight	: 17 kg
Standard Packing	: 1 pc



Vacuum Cleaner

AR-80

HSN Code (GST-%)	: 85081900 (18%)
Power	: 4500 W
Vacuum Suction	: 280 m Bar
Capacity	: 80 Ltr
Height	: 95 cm
Diameter	: 43 cm
Airflow	: 120 L/S
Function	: Wet/Dry
Voltage	: 220V-240V
Gross Weight	: 27.8 kg
Standard Packing	: 1 pc

SPRAYER PUMP



SPRAYER PUMP

AR-50P

HSN Code (GST-%)	: 84244900 (12%)
Normal Pressure	: 200 PSI / 14 Bar
Maximum Pressure	: 500 PSI / 35 Bar
Pump R.P.M.	: 800/1200 R.P.M.
Stroke Length	: 20 mm
Piston Diameter	: 30 mm
Piston Material	: Stainless Steel
Pump Material	: Cast Iron
Oil Chamber Material	: Alluminium
Motor HP	: 2 HP
Water Suction L.P.M.	: 30-50 L.P.M.
Approx Weight	: 11 kg.



HIGH PRESSURE WASHER

AR-2000

HSN Code (GST-%)	: 84248990 (18%)
Voltage	: 220
Power (Kw)	: 1.5kw - 2HP
Working Pressure (Bar)	: 80-100
Flow Liter/Min	: 10L
Power RPM	: 2800
Approx Weight	: 12kg.
Standard Packing	: 2 pcs.

FOAM BOTTLE

AR-199G

HSN Code (GST-%)	: 84248990 (18%)
Colour	: White & Black
Included	: Nozel & Spray
Weight	: 199 gms.
Material	: Plastic
Bottle Capacity	: 1 Ltr.
Product Dimensions	: 12 x 4 x 7
Standard Packing	: 10 pcs.



HIGH PRESSURE WASHER

AR-2100

HSN Code (GST-%)	: 84242000 (18%)
Voltage	: 220
Power (Kw)	: 2.2kw 3HP
Working Pressure (Bar)	: 120 Bar - 1800 psi.
Flow Liter/Min	: 15 ltr.
Power RPM	: 2800
Approx Weight	: 38kg.
Standard Packing	: 1 pc.



WELDING MACHINE

AR-200G

HSN Code (GST-%)	: 85158090 (18%)
Input Voltage	: 1 PH-AC 200 V
Input Power (kva)	: 5.24 KVA
Max. Output Current (A)	: 160
Duty Cycle @ 40°C	: 60%
No Load Voltage (V)	: 65
Protection & Insulation	: IP 21 & F
Dimensions (mm) Approx	: 395x153x301
Weight (kg)	: 5 kg



PAINT GUN		AR-827
HSN Code (GST-%)	:	84242000 (18%)
Operating Pressure	:	20-25 psi
Feed	:	Gravity
Nozzle Size	:	0.5 1.0 1.2 mm
Air Inlet	:	1/4"
Fluid Output	:	70 ml/min
Pattern Width	:	170mm
Cup Capacity	:	500 gms.
Air Consumption	:	85 ltr/min
Weight Without Cup	:	300gm
Product Size (l x b x h)	:	7.4x4x4.2 inch
Standard Packing	:	20 Pcs.



AIR BLOW GUN		A-DG10
HSN Code (GST-%)	:	84242000 (18%)
Body	:	Aluminum
Working Pressure	:	0.2-0.6
Stranded Length (mm)	:	50.5
Nuzzle Size (mm)	:	Ø3.4
Standard Packing	:	50 pcs.



DIESEL GUN		AR-DO10
HSN Code (GST-%)	:	84242000 (18%)
Operating Pressure	:	40-60 psi
Cup Capacity	:	750 ml
Nozzle Size	:	3 mm
Feed	:	Suction
Air Consumption	:	226 ltr/min
Material Output	:	125 cc/min
Air Inlet	:	1/4"
Weight	:	740 gm
Product Size (l x b x h)	:	15.12x5.12x4.72 inch
Standard Packing	:	10 Pcs.



PRESSURE GAUGE		AR-TG02
HSN Code (GST-%)	:	84242000 (18%)
Range	:	0 to 170 psi.
Item Part No.	:	Inflator Gun
Hose Size	:	15 Inch
Item Weight	:	320 gms.
Dia Miter	:	63 mm (2.5 Inch)
Standard Packing	:	10 pcs.

AIR DIE GRINDER		AR-3/8
HSN Code (GST-%)	:	84678990 (18%)
Free Speed	:	25,000 rpm
Colett Size	:	1/4" (6 mm)
Air Inlet	:	1/4"
Air Hose (I.D.)	:	3/8"
AVG Air Consumption	:	4 CFM
Working Pressure	:	90 Psi (6.3 Bar)
Length x Height	:	6.81" x 2.68" (lInch)
Weight	:	390 gm
Standard Packing	:	20 Pcs.

SPARES



SAW CHAIN

AR-59/72/86

Size	: 16" / 18" / 22"
Standard Packing	: 50 pcs.

IMPACT WRENCH SPARE PARTS

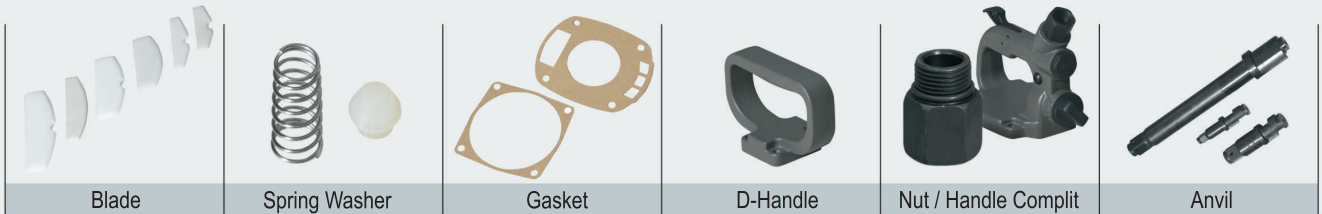

Blade

Spring Washer

Gasket

D-Handle

Nut / Handle Compli

Anvil

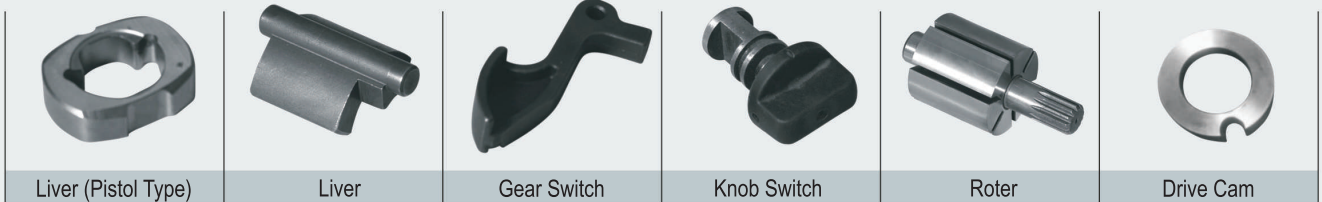

Liver (Pistol Type)

Liver

Gear Switch

Knob Switch

Roter

Drive Cam



Front Cylinder Cover

Front Body

Bushing

Hammer Frame Lid

Cylinder

Drive Cam



Socket Light

Socket CRV

Socket CRMO

FRL SPARES





Lubricator Oil Cap

Filter Bowl Metal & Glass





Regulator Diaphragm

HIGH PRESSURE SPARE





HIGH PRESSURE SPARE

					
90Degree Adaptor	Pump Head	Steel Wire Pipe 8mm	Hose Pipe	Plastic Quick Release	Pressure Remaining Valve







					
Oil Seal	Extension Pipe	Inlet Conector	Water Seal	Nozzle	Outlet Valve & Plunger

					
Spring	Quick Release Adaptor	Nylon Pipe 8mm	Filter	Spray Gun	

VACCUME SPARE PARTS

					
1200W Motor	1500W Motor	Hose Pipe	Filter	Wet Dry Brush	

SPAREY PUMP SPARE PARTS

					
Crank Shaft	Connecting Rod	Piston & G.Pin	Vassal	Fly Wheel	Body

					
Oil Seal	NRV	Saveran Ring	NRV Ring		

AIR COMPRESSOR SPARE

AIR COMPRESSOR SPARE PARTS

					
Connecting Rod	Gasket	Oil Plug & Indicator	Piston Ring	Head	Crankshaft
					
Solenoid Valve	Oil Free Ex. Pipe	Check Valve (NRV)	Sefty Valve	Pressure Gauge	Quick Coupler
					
Protector Switch	Oil Free Crank Shaft	Oil Free Connecting Rod	Switch Bracket Complet	Outlet Valve	Motor Starter
					
Block	Wheel	Oil Free Chamber	Direct Driven Chamber	Regulator Assembly	Oil Free Piston Ring
					
Air Filter	Oil Free Piston	Valve Plate	Connector	Auto Switch	Air Filter Oil Free

TROLLY PUMP SPARE PARTS

					
Cranks Shaft	Connecting Rod	Piston	Oil Seal Spring & NRV		



Airotic

Importer, Marketed & Exporter



Mktd. By :

Shiv Manufacturers
Rajkot (Guj.) INDIA.

E-Mail : shivmanufactures.gati@gmail.com
www.shivmanufactures_gati.com

